

Transmutation of metal at low energy in a confined plasma in water

D. Cirillo - V. Iorio

domenico.cirillo@poste.it vincenzo.iorio@email.it

Laboratorio M. Ruta - 81100 – Caserta, Italy

August 2004

Abstract:

Energetic emissions have been observed from an electrolytic cell when tungsten electrodes are used to generate a confined plasma close to the cathode immersed an alkaline solution. In addition, energy generation has been observed, always close to the cathode, along with the appearance of new chemical elements in the experimental apparatus. These elements were not present in the cell before the experiment. This observation is proof of nuclear transmutations occurring within the cell. The results of this research and a theoretical proof of the phenomenon were shown for the first time on April 18, 2004 during the second Grottammare (Ap) ONNE meeting in Italy.

1. Introduction

The new cells described here produce many simultaneous interactions of a chemical and physical nature. Analysis of these events requires a multidisciplinary approach, and opens a complex and not yet completely understood nuclear mechanism. Due to this complexity, the mathematical model needs more study.

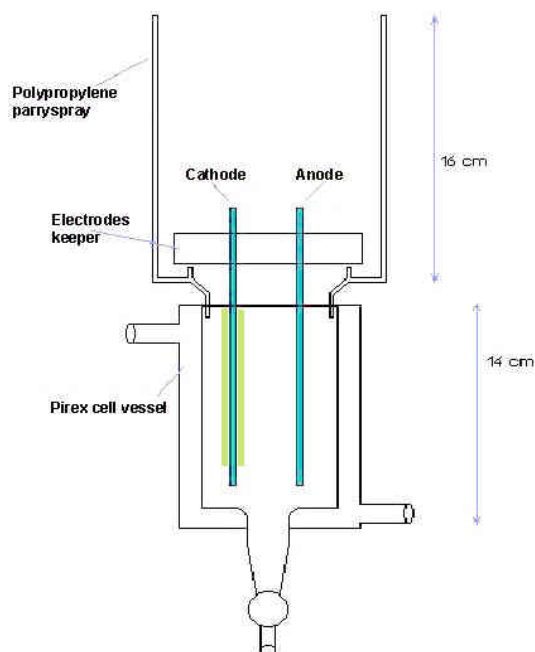

Fig. 1. Configuration of the cell and position of the electrodes

2. Cell configuration

The cell, shown in Fig. 1, is made from a 350 ml Pyrex container surrounded by a jacket and having an open top. The jacket is evacuated using a vacuum pump in order to reduce thermal loss. On the top side of the cell is located a cylindrical shield made of polypropylene with a diameter of 13 cm. and a height of about 16 cm. A lid made of Plexiglass closes the cell top. The electrodes, a thermocouple and a mercury thermometer pass through holes in the lid.

The electrodes are cylindrical rods with a diameter of 2.45 mm, and a length of 17.5 cm. Both are made of pure tungsten, with a combined volume of 3.8 cm^3 . The cathode is partially covered with a ceramic sleeve, which allows us to control the dimensions of the exposed cathode surface submerged in the reacting solution. Transducers are placed close to the cell and connected to various measuring instruments, consisting of a pyrometer and light-meter to measure the light variations occurring inside the cell, and a Geiger counter, to measure the radiant emission caused by nuclear events. We find that RF interference can cause incorrect readings. This will be discussed later. The cell is powered by a direct current power supply able to output a variable voltage from 0 to 340 volt and a maximum current of 8 Amp. The electrolytic solution is potassium carbonate (K_2CO_3), 0.2 M concentrated in 200 ml of ultra pure water (double-distilled), which has a pH greater than 10. This solution is standardized with a volume of $200 \pm 0.5 \text{ ml}$ at 20°C . The solution is heated to 70°C so that an electrical conductivity of $12000 \mu\text{S}$ is obtained. This condition favors formation of a plasma and facilitates the nuclear events, as we will explain below. From a thermodynamic point of view, the cell is a non-adiabatic calorimeter, because it loses heat from the top, and constant pressure, because it is always in contact with the ambient atmosphere. Even a strong vapor emission is quickly dispersed without over-pressure generation.

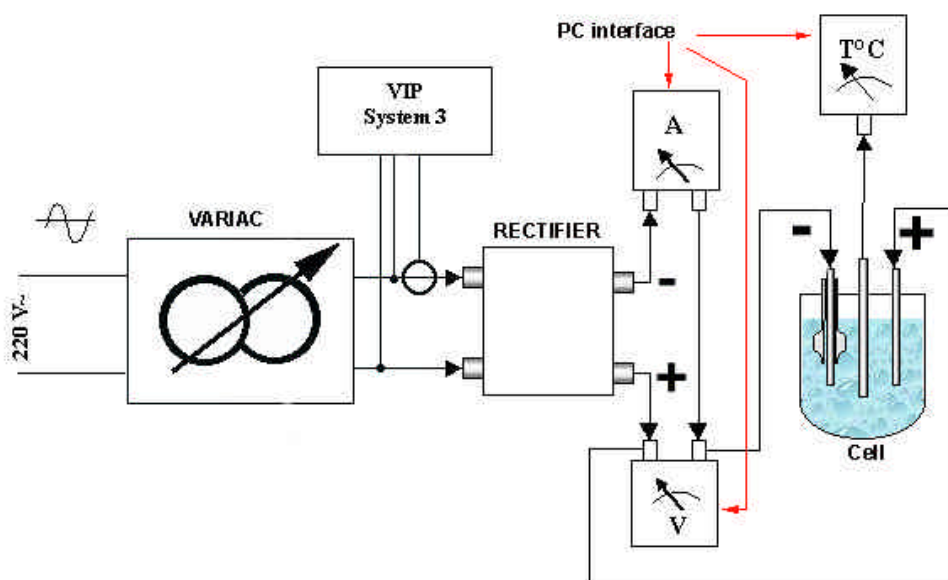

Fig. 2. General layout of the cell system.



Fig. 3. Electrochemical Plasma Cell

3. Electrochemical Plasma Cell working conditions.

Application of the voltage causes H^+ to migrate to the cathode (the electrode that is at negative potential) and OH^- to migrate to the anode (the electrode at a positive potential). This ionic flux allows current to pass through the cell and produces hydrogen at the cathode and oxygen at the anode. The oxygen is produced through the ionic OH^- discharge at the anode, and the hydrogen mainly through the direct discharge of the water molecule at the cathode, following the reactions:

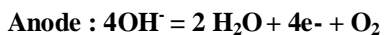

The overall cathode reaction is strongly enhanced by the electrolytic. For example, the potassium ions (K^+) that are dissolved in the solution have a greater oxidation potential than hydrogen. The cathode reaction will last until all the hydrogen disappears from the solution. Simultaneously, the potassium ions will condense around the cathode, without depositing on it, thereby generating a screen with a positive potential that holds itself a few nm from the electrode. This peculiar configuration is similar to a cathode condenser in which the positive electrode is created by the potassium ions and the negative electrode is the cathode itself. In this situation, the dielectric is the double layer consisting of H_3O^+ and H_2 located between the two electrodes. In spite of this screen of potassium ions, ions of the hydrogen, being much smaller, will continue to discharge on the cathode without difficulty and generate gaseous hydrogen. (Hydrogen ions are so small, they are practically protons, in some ways.)

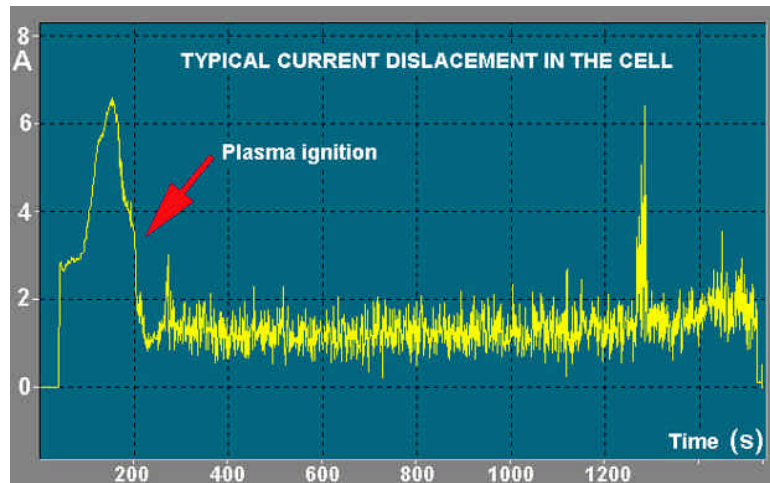

Fig. 4. Current displacement in our cell

Normal electrolysis occurs as long as applied voltage is around 50 - 80V. As the voltage is increased on the order of hundreds of volts, the amount of hydrogen generation increases significantly. Eventually, so much hydrogen is being formed that it blocks the electrode. This causes the resistance of the cell to increase according to the equation $R_{(T)} = R_{(T_0)} * [1 + \alpha(T - T_0)]$ in which $R_{(T)}$ is the actual electrical resistance, $R_{(T_0)}$ is its value at 20°C, “ α ” is coefficient typical for tungsten (0.0045), and T is the temperature at which resistance is measured.

Once the region near the cathode acquires a sufficiently high resistance, the voltage drop between the potassium ion shield and the cathode can cause a plasma to form, thereby forming a gaseous dielectric. The new condition can be represented with the equivalent circuit as shown in Fig. 5, where Z_f is the Faraday impedance.

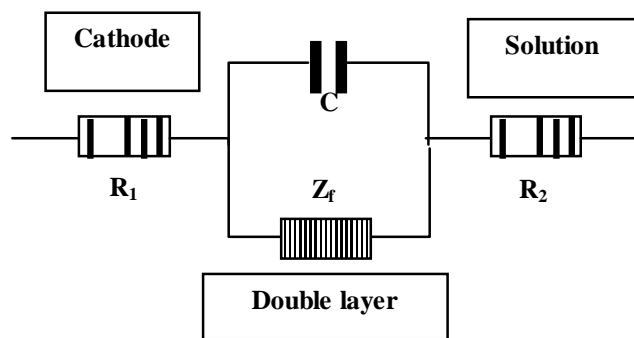

Fig. 5 Electronic representation of the double layer.

This plasma is unstable and will tend to be strongest where the voltage is greatest (see Fig. 6). The high local voltage is able to excite hydrogen and potassium ions to energies that result in optical emissions. In addition, the tungsten rod is heated to a temperature that produces electron and light emission. As a result, strong RF emissions are produced that can interfere with measurements if adequate shielding is not used.

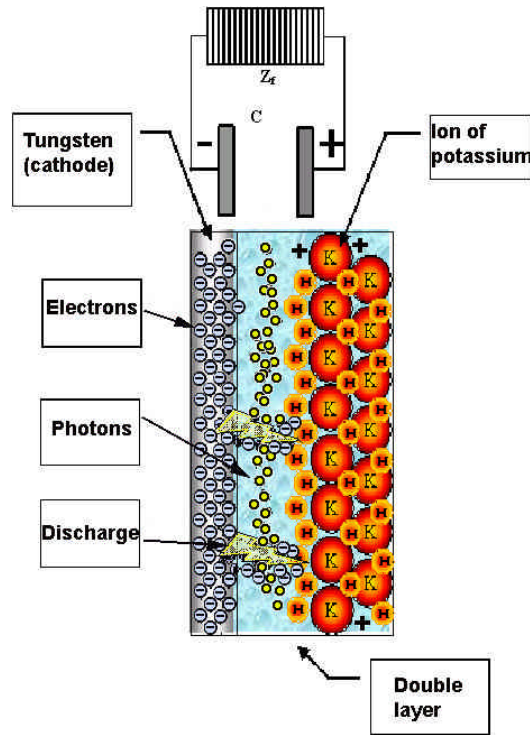

Fig. 6. Describing the Double layer during the ignition phase

All together this phenomenon rises the cathode temperature close to 500°C., giving birth to an important consequence: the water in the solution, finding itself very close to the cathode, will evaporate instantaneously, generating a sort of vapor-sleeve.

As a result, the electrical conduction mechanism in the cell changes. The region covered by plasma is much less involved in electrical conduction through the cell causing conduction to shift to the upper cooler part of the cathode, called “**reaction band**”, where gaseous hydrogen continues to be produced, but hydrogen formation is reduced. This causes the current to stabilize at about 1 - 1.5 A, as observed during the ignition phase (see Fig. 4). The limiting current value depends only on the ion concentration. This demonstrates that when the cathode surface is covered with the plasma, electrical conduction is drastically reduced and electrical potential lines are obliged to concentrate at colder areas, as shown in Fig. 7.

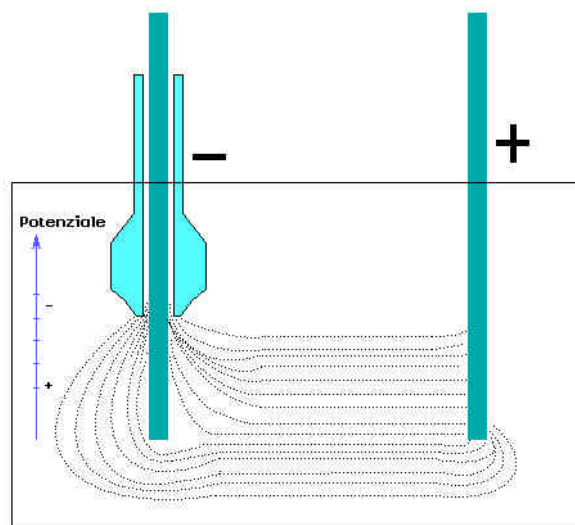

Fig. 7. Flux of the ions in the solution

Important to the process is the cathode ceramic sleeve, called “**reaction chamber**”, which offers, thanks to its geometry, the correct electrical stability to the plasma. The internal diameter of the reaction chamber is larger than the cathode diameter by few millimeters.

The following X-ray photos picture (Fig. 8, 9) show the tungsten surface after a good test of 4000 seconds. Photo 1 shows very little etching of the surface, while Photo 2 shows areas where tungsten melted, indicating a temperature higher than 3400°C.

Worm gas erosion

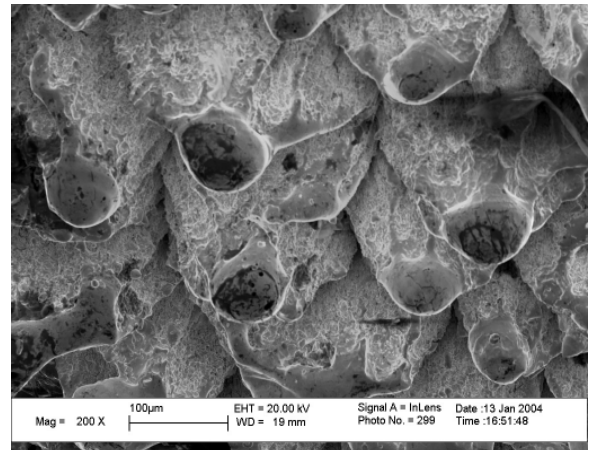
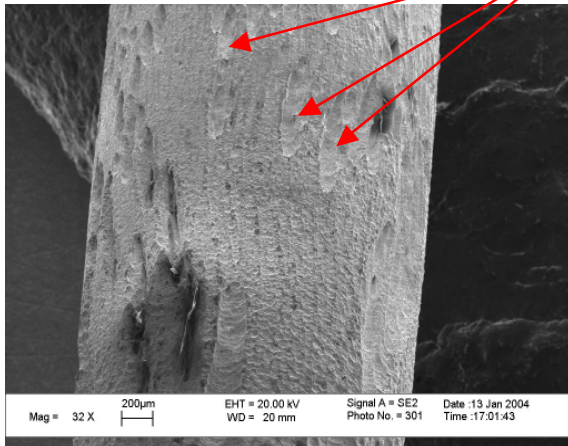

Fig.8. Areas etched by hydrogen gas

Fig.9. Tungsten fusion area (after 4000 sec.)

Important to creating a model is the realization that temperatures in excess of 1000° C are produced, and they sometimes as high as 3400°C. Such temperatures generate thermionic emission, which must be considered.

We propose that as the temperature increases, electrons in the metal start to oscillate in a coherent way. This oscillation is attracted toward the metal surface by the surrounding positive potassium ions. In addition, at temperatures close to 3400°C, thermionic emission can generate as much as 500 amperes from the heated part of the cathode. (See Fig. 10). Therefore, a considerable number of electrons are available to the surface region. We believe this condition is important to initiating the observed transmutation reactions.

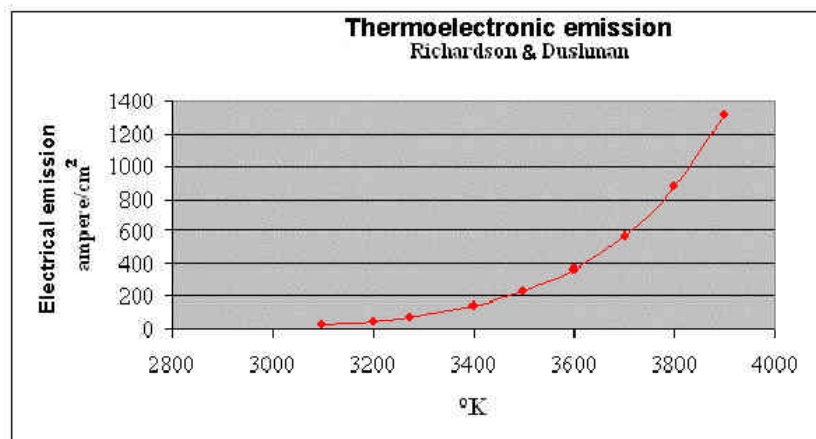

Fig. 10. Tungsten thermoionic emission

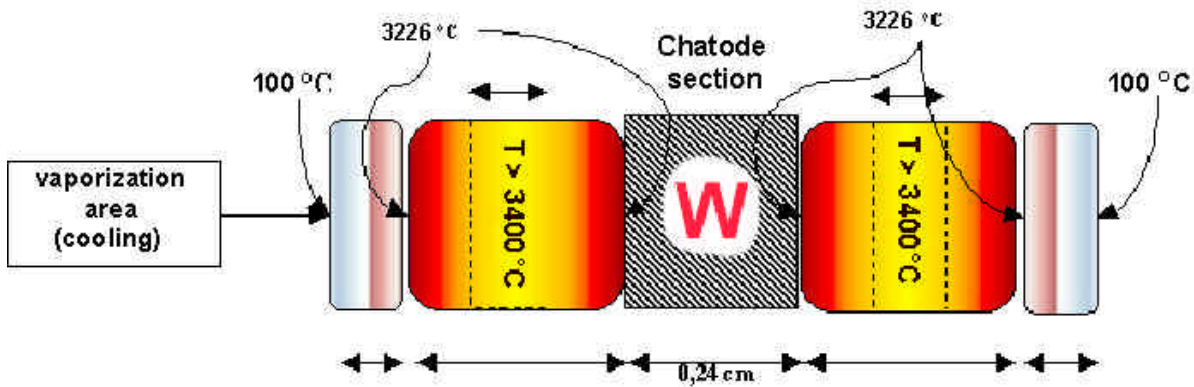

Fig. 11. View of the plasma heat transfer mechanism

4. Experimental evidence

Once a stable plasma has been achieved for more than 500 sec., we can compare the input energy, electrical power, with the quantity of energy necessary to warm up and evaporate the solution water. Omitted from this calculation is energy associated with chemical reactions; energy related to the heating-up and fusion of the tungsten; energy used in expanding gas and steam leaving the cell; energy lost by thermal and electromagnetic radiation; and loss of heat through the insulation. Even though this extra energy is omitted from the calculation, the cell is found to produce more energy than is being applied. If the energy needed to warm-up the electrolyte to 100°C and then produce evaporation is taken into account, values of output/input = 1.2 to 1.4 are obtained.

Using an SEM (scanning electron microscope), the presence of rhenium, osmium, gold, hafnium, thulium, erbium, and ytterbium are found on the surface of the cathode. These elements were not previously in the apparatus (see Fig. 12, 13, 14).

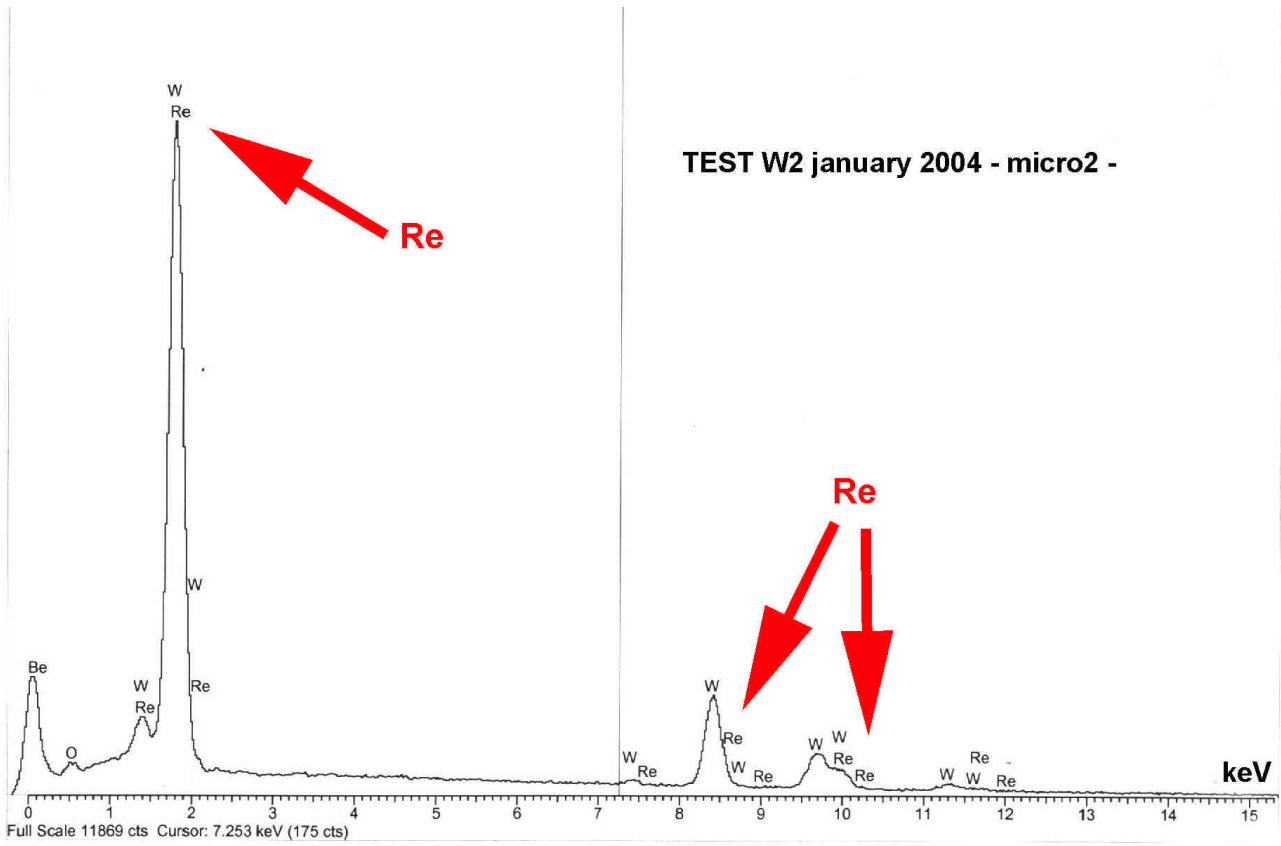

Fig. 12. Analysis executed with an SEM on an area of the cathode surface after 4000 seconds of plasma – January 2004.

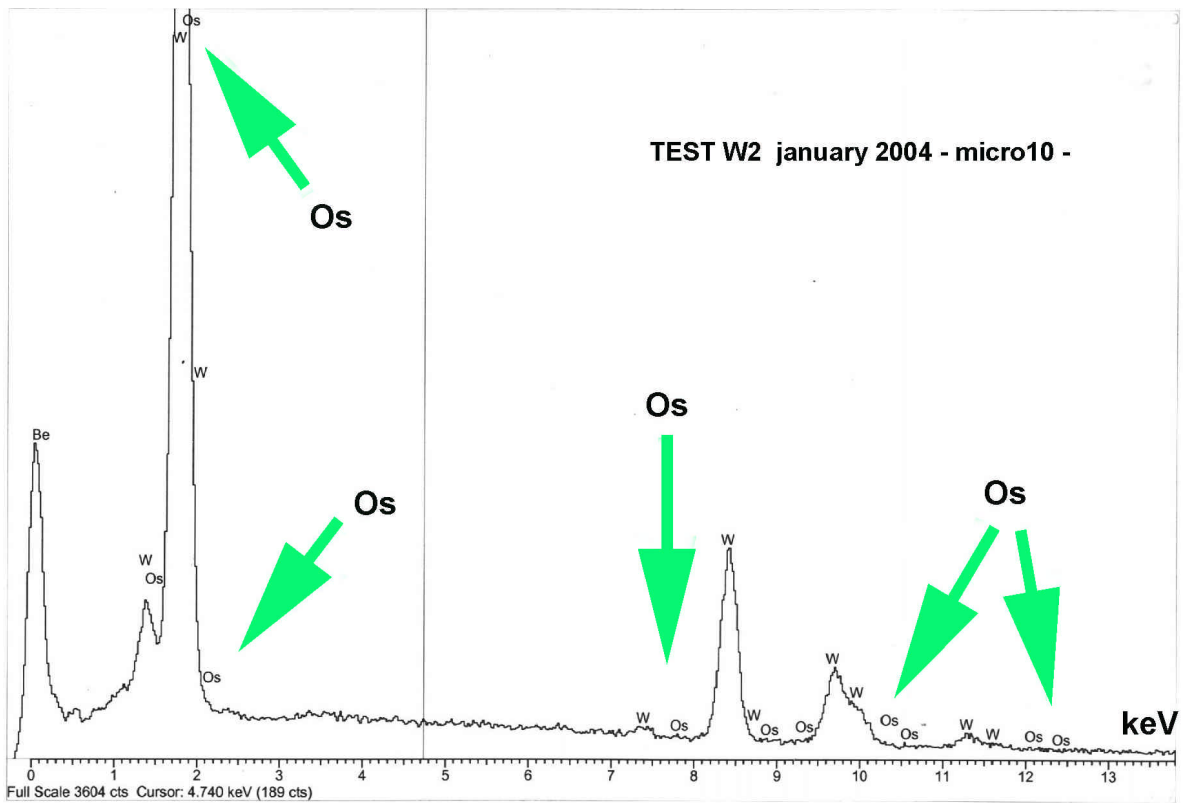

Fig. 13. Analysis executed with an SEM on an area of the cathode surface after 4000 sec. of plasma – January 2004.

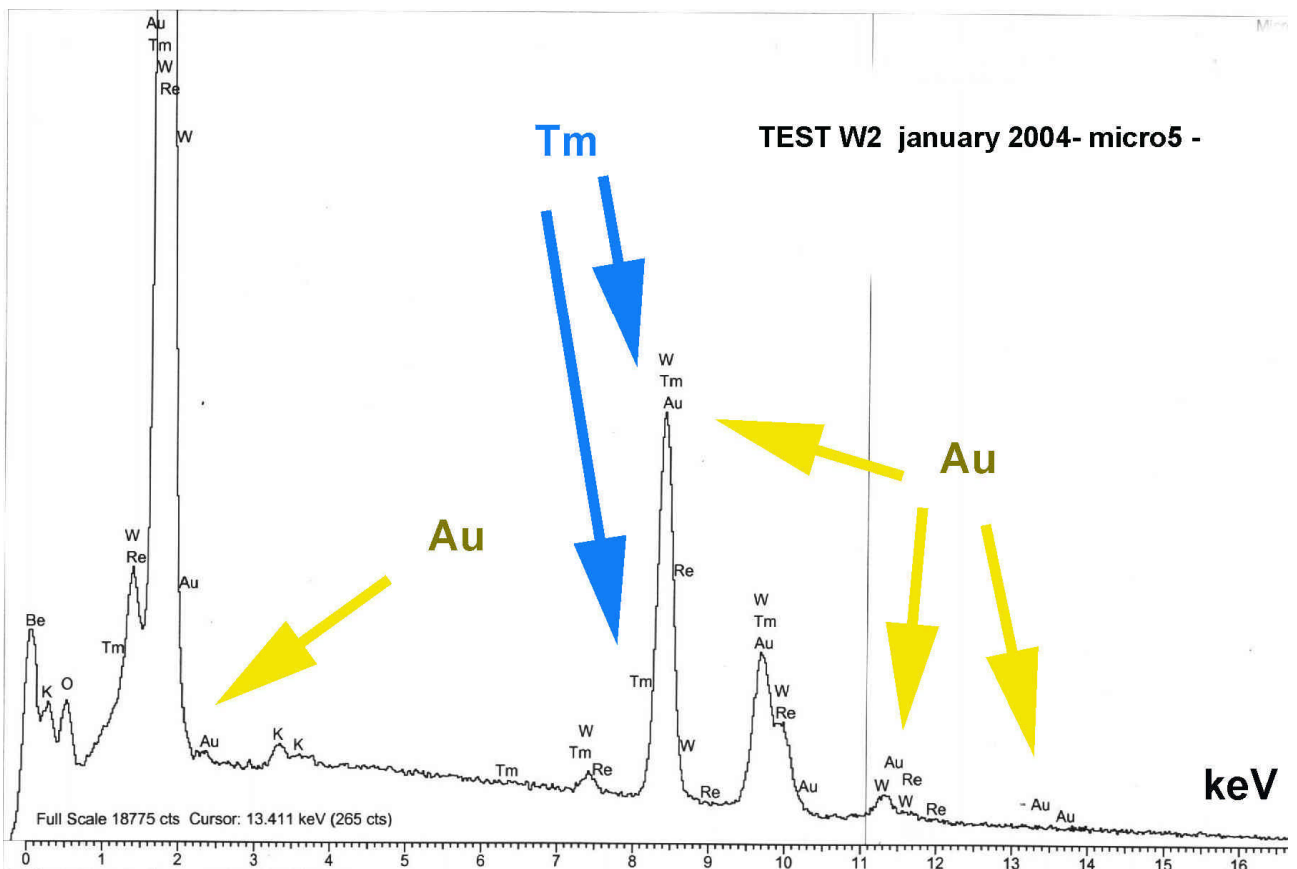

Fig. 14. Analysis executed with an SEM on an area of the cathode surface after 4000 sec. of plasma – January 2004.

5. Thermodynamic problems and output energy measurement

The cell is heated mainly by resistive heating and by radiation from the plasma at the cathode. The following formula is used to calculate the energy resulting from these processes.

$$Q_{uscita} = m_{H_2O} \cdot (T_2 - T_1) \cdot cp_{H_2O} + m_v \cdot 539,55$$

With m_{H_2O} is the solution initial quantity (200cc.), cp_{H_2O} is the specific heat at constant pressure, m_v is the amount of water lost by vaporization, 539,55) is the heat of vaporization given in cal/g, and (T_2-T_1) is the initial and final temperature of the cell. This method gives a precision of +/- 250 cal.

Additional factors must be taken into account, including splitting of water into its elemental components. This involves the following reaction, which removes energy from the system.

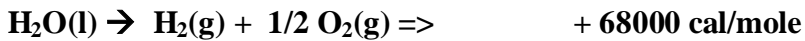

Energy is used to oxidize tungsten at the anode, as shown by the following reactions.

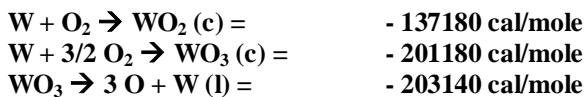

These reactions remove tungsten from the anode and enrich the solution with tungsten oxides. Being exothermic, these reactions add heat to the solution. However, the amount of energy contributed by these reactions is very small.

Strong electromagnetic disturbances in the frequency range between kHz and hundred of MHz, are generated (see Fig. 15). These signals originate from the plasma in spite of the surrounding liquid.

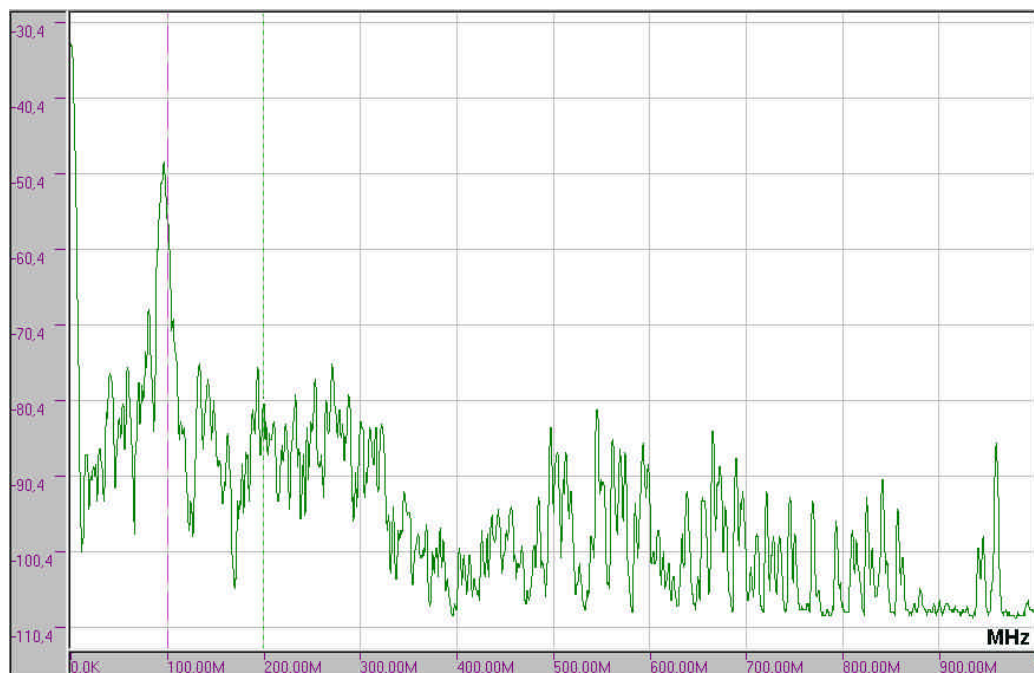

Fig. 15 Electromagnetic spectrum during plasma ignition

The cell can be analyzed as an electrical circuit shown on fig.17

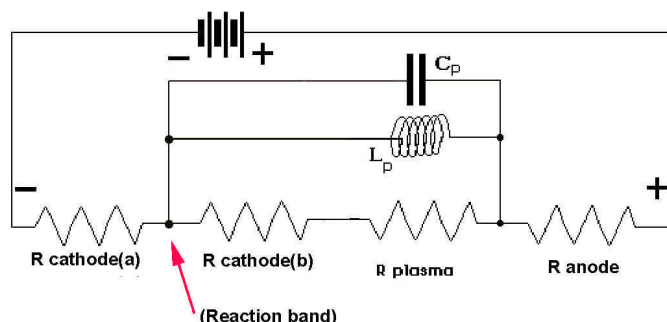

Fig. 17 Equivalent circuit of the cell during plasma phase

C_p is the tungsten-potassium virtual condenser and L_p is the plasma inductance. This equivalent circuit allows the oscillations that produce electromagnetic emissions to be analyzed. The equivalent circuit shows a cathode resistance made of two terms (R_a and R_b), which provide most of the ohmic heating. The highlighted point by the arrow shows the area called ‘reaction band’, which, as explained above, maintains the cell current once a plasma has formed. A complete analysis of the emitted electromagnetic spectrum should allow the energy generated at R_a and R_b to be determined. At the moment these data are still to be determined.

The work of expansion has not been evaluated because the volume of gas has not yet been determined. Therefore, we have not been able to give a value to the ‘ ΔV ’, which appears in the equation:

$$E_{(\text{expansion})} = P * \Delta V$$

This equation gives the energy associated with expansion of the generated gases when the pressure, P , is fixed.

The thermal losses from the system are approximately 25% of the input energy (Q_{input}). This means that when 100 cal is applied to the cell, 75 cal. will be transformed into heat to warm the solution and 25 cal will be lost to the environment through the insulation.

Conclusions

The plasma is able to initiate transmutation reactions. Future studies are underway to understand the mechanism of these reactions. We propose that these reactions are the main source of measured excess energy.

References

Ohmori, T. and T. Mizuno. *Strong Excess Energy Evolution, New Element Production, and Electromagnetic Wave and/or Neutron Emission in the Light Water Electrolysis with a Tungsten Cathode*. in The Seventh International Conference on Cold Fusion. 1998. Vancouver, Canada: ENECO, Inc., Salt Lake City, UT. (ICCF-7)

Scott R. Little, H. E. Puthoff Ph.D., and Marissa E. Little, *Search for Excess Heat from a Pt Electrode Discharge in K₂CO₃-H₂O and K₂CO₃-D₂O Electrolytes*, September 1998

Ohmori, T. and T. Mizuno, *Nuclear transmutation reaction caused by light water electrolysis on tungsten cathode under incandescent conditions*. Infinite Energy, 1999. 5(27): p. 34.

D. C. Borghi, D. C. Giori, A. Dall'Olio, CEN, Recife, Brazil, *Experimental Evidence for the Emission of Neutrons from Cold Hydrogen Plasma*, Unpublished, (1957).

Monti, R.A., *Low energy nuclear reactions: Experimental evidence for the alpha extended model of the atom*. J. New Energy, 1996. 1(3): p. 131.

Monti, R.A., *Nuclear Transmutation Processes of Lead, Silver, Thorium, Uranium*. in The Seventh International Conference on Cold Fusion. 1998. Vancouver, Canada: ENECO, Inc., Salt Lake City, UT.