

# **Transmutation of metal to low energy** **In confined plasma in the water**

## **Electrochemical Plasma Cell**

D. Cirillo, A. Dattilo, V. Iorio

E-Mail : D. Cirillo [domenico.cirillo@poste.it](mailto:domenico.cirillo@poste.it)  
V. Iorio [leptone@inwind.it](mailto:leptone@inwind.it) – [vincenzo.iorio@marconi.com](mailto:vincenzo.iorio@marconi.com)

### **Abstract:**

Elevated energetic fluxes have been noticed inside an electrolytic cell working in alkaline surrounding, using tungsten electrodes to start the generation and the confinement of a plasma close to the cathode. Together, have been noticed energy generation, always close to the cathode, with the appearing of new chemical elements which where absent, at the beginning, in the experimental apparatus. That is a tangible proof of some nuclear transmutations. The results of this research, the theoretical frame of the phenomenon that plays a role on it have been, for the first time, showed-up at the 18<sup>th</sup> of April 2004, during the second Grottammare (Ap) ONNE meeting, in Italy

### **1. Introduction**

The novelty related to this new cells typology is given due to the simultaneously, other than interactions, of a variety of chemical and physical phenomenon which, working in a synergy situation, are able to generate a cascade of events that shows-up experimental evidences for which the analysis can't be reduced and approached only from a single scientific discipline, but with consequences opening in complex and, not yet completely clarified mechanism of nuclear nature. Due to this complexity, the mathematical, rigorous model definition, describing the abundance of processes playing a role, need a more profound thinking and more research and experiments.

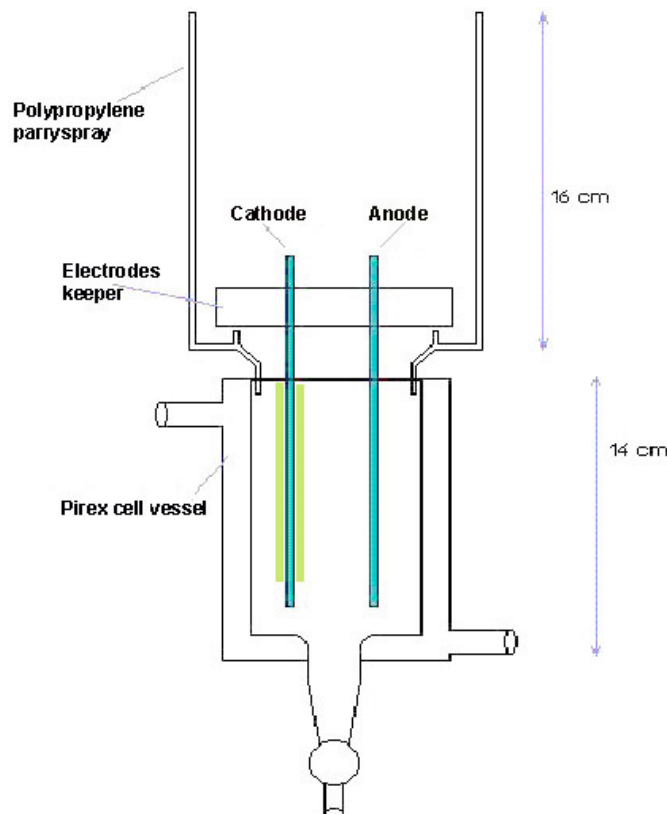


Fig.1 Configuration of the cell and position of the electrodes

## 2. Cell configuration

The cell, shown in fig.1, is made by a transparent Pyrex vessel with a double wrapping, and no top, capable of a 350ml of capacity. A void is achieved, between the two wrappings, through the use of a vacuum pump, with the aim of reducing the lateral thermal losses. On the top side of the cell is located a cylindrical parryspray made of polypropylene with a diameter of 13 cm. and an height of about 16 cm. On the top part of the vessel we have the electrodes- keeper, made of plexyglas, onto which the electrodes are placed. Some other holes are able to support a thermocouple or a mercury bulb thermometer.

The electrodes are made by cylindrical rods with a diameter of 2.45 mm. length 17.5 cm., both in pure tungsten, with a displacement of 3.8 cm. between them. The cathode is partially covered with a ceramic sleeve which gives the possibility to expose a dimensionally controlled surface submerged into the reacting solution. Close to the cell, are placed some transducers, related to various measuring instruments; pyrometer and luxmeter to measure the light variations occurring inside the cell; a Geiger, to measure the radiant emission due to nuclear events. (i.e., we noticed that because of the phenomenon peculiarity, an electromagnetic disturbance appears. If they are not adequately controlled and screened, the measuring apparatus could fail; we'll say more about it later on). Above the parryspray a suction chamber leads the resulting gases and steam towards the outside to prevent that their heaping inside the electrodes electrical connections box will cause a dangerous short-circuit.

The cell is powered D.C. through a generator able to output a variable voltage from 0 to 340 volt and a maximum current of 8 Amp. An electronic interface, thought and developed by our team, is able to collect all signals from the instrument transducers. In this way we are able to monitor constantly, voltage, current, temperature, radiometer emission and light intensity from the cell.

The value of the electric energy we give at the system entrance is checked by an energy-counter, model VIP System (Elcontrol) connected first to the power regulating system. This solution gives us some accuracy about the reliability of the measured input energy.

The electrolytic solution is constituted with potassium carbonate ( $K_2CO_3$ ), 0.2 M concentrated in 200 ml of ultra pure water (double-distilled) which determines an alkaline surrounding ( $pH > 10$ ). This solution is prepared through a standardized procedure that allows the measure of the 200 ml of volume with an accuracy of  $\pm 0.5$  ml at  $20^\circ C$ . Once prepared, the solution is heated till a temperature of  $70^\circ C$ , in such a way is able to present an elevated electrical conductivity easing to reach the limit of the  $12000 \mu S$  related to the conductivity of the solution at  $100^\circ C$ . This situation favors the plasma establishment and facilitates the ensnaring of the nuclear events we'll explain later on.

From a thermodynamics point of view, the cell is identifiable like a non-adiabatic calorimeter, because it loses heat from the top, and isobar, because it is always in contact with the atmospheric external pressure; even with a strong vapor emission, it is quickly dispersed without over-pressure generation.

Fig. 2 General layout of the cell system.

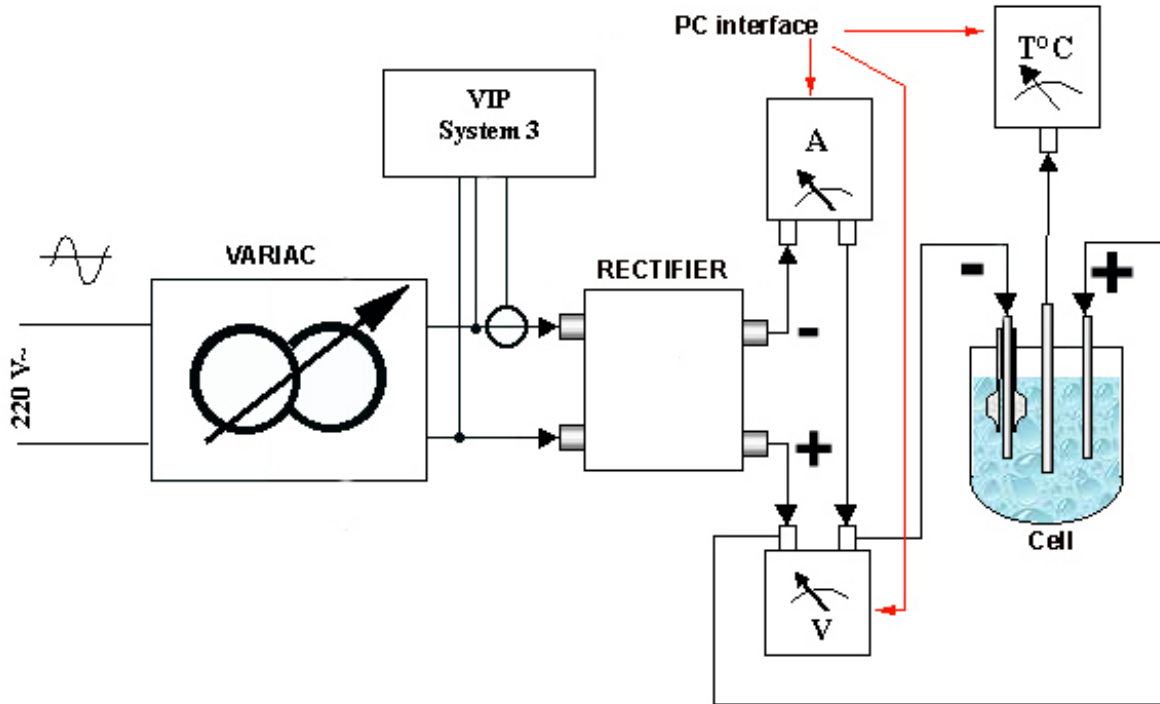
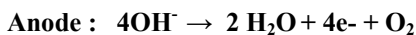


Fig. 3 Electrochemical Plasma Cell



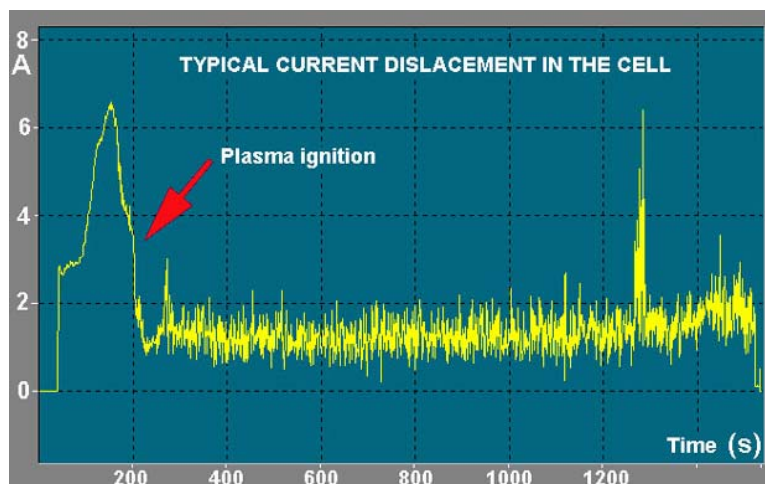
### 3. Electrochemical Plasma Cell working conditions.

Transferring energy to the cell, through the voltage generator, causes a hydrogen positive ionic migration ( $H^+$ ) towards the cathode (electrode that is at negative potential) and a flux of ionic oxidants ( $OH^-$ ) towards the anode (electrode that is at a positive potential). This ionic flux allows currents transfers inside the cell, that, as a return, produces notably hydrogen quantity at the cathode and oxygen at the anode, in which quantity are calculated via the classical electrochemical reaction inside an alkaline environments ( $pH > 10$ ). The oxygen is produced through the ionic  $OH^-$  discharge at the anode, and the hydrogen mainly through the direct discharge of the water molecule at the cathode, following the reactions:



The global cathode reaction is strongly enhanced, also, by the electrolytic used in the solution. In the cell under investigation, for example, positive potassium ions ( $K^+$ ) are dissolved into the solution, showing a major oxidation potential than the hydrogen. The cathode reaction will last until all the hydrogen disappears from the solution. Simultaneously, the potassium ions will condensate around the cathode, without discharging on it, generating in this way a sort of screen with a positive potential that holds itself a few nm from the electrode. This peculiar configuration is similar to a cathode condenser for which the positive shield is given by the potassium ions, the negative shield is the cathode itself, instead the dielectric is the double layer  $H_3O^+$  and  $H_2$ . Having this screen of potassium ions, the ions of the hydrogen, being a lot smaller, (they are practically protons, in some way); will continue to discharge on the cathode without difficulty of any sort, generating again and again gaseous hydrogen.

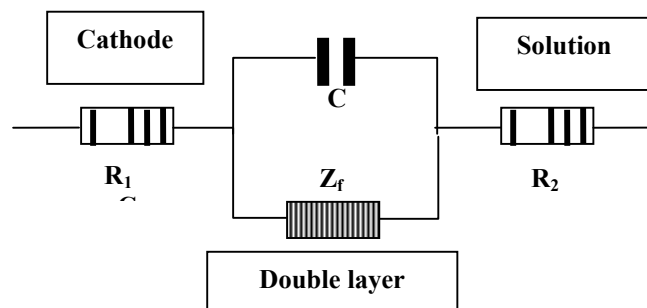
**Fig. 3.2 Current displacement in our cell**



This normal electrolytic regime, coming-up from the hydrogen production over the double layer and from the cumulating potassium ions in close proximity of the same electrode, is going on for all the time in which the potential applied to the cell is lower than a fixed value, that with our electrolytes concentration (0.2 M), is around 50-80 V. Successively, such potential difference applied to the cell, is increased till will assumes values on the order of hundreds of volts. During the transitory can

be noticed an increase in intensity and, visibly, a corresponding increases in the hydrogen production, as described by the already known Faraday laws of electrolysis. See figure 3.2. Everything prosecutes until some specific conditions are met: onto a few spots in the cathode, the abundant hydrogen bubbles produced are generating isles of electrical insulation establishing truly localized current interruptions; contemporarily, due to the Joule effect, the electrode heat-up and, as a consequence, is going to be less conductive following the relation  $R=R'(1+\alpha T)$  in which  $R$  is the actual electrical resistance,  $R'$  is its value up to  $20^{\circ}\text{C}$ , " $\alpha$ " is coefficient typical for the tungsten 0.0045,  $T$  is the temperature during the time the actual resistance is measured. This situation determinate the grow, between the potassium screen and the cathode, of a purely gaseous dielectric which is notably limiting the electrical conductivity, increasing, on the contrary, the local potential and linked to it, the local electrical field. The new situation can be represented with the equivalent circuit where  $Z_f$  is Faraday impedance, parameter always present in any electrolytic cell:

**Fig. 4 Electronic representation of the double layer.**



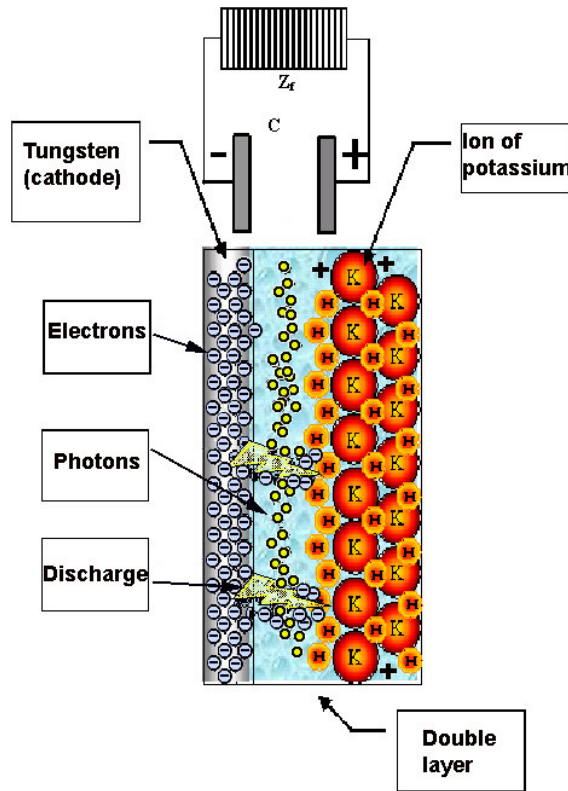
The presence of this electric field, constantly increasing, joined with the reduced conductivity, will determinate, at certain time and in localized zones, the upsurge of disruptive electrical discharges between the potassium armature made of ions and the tungsten cathode. The bursting-up of these discharges comes exactly where the electrical field is really big, means, along the electrode boundaries. The further heating-up of the ignition zone is going to determinate an increasing of the current lines dispersion and the extension of this disruptive charges along the entire electrode surface until it will constitute a real plasma macroscopically visible surrounding the cathode completely and remaining stable and confined. Can be noticed, in this phase, an always diminishing number of hydrogen discharging points on the electrode cause multiple factors; say, a minor density of current lines, linked to the temperature dispersion effect; a constraining thermal effect that blocks electrons about forming H-H links, cause the continuous excitation by an increasing numbers of photons and inelastic clashes between the same electrons. In this phase, can be registered optical emissions, hydrogen characteristic, and cations condensing on the double layer; a tangible sign that some of them, being part of the positive armature, participate to the electronic transitions that gives luminosity to the plasma.

Some other consequences of the cathode overheating are its emission of electrons cause the term ionic effect that are going to join the already protons rich double layer coming from the solution and photons coming from the discharges onto the tungsten rod (see fig. 5).

With the plasma ignited very strong electromagnetic disturbance appears. If they are not adequately screened, you could report false reading values from the electronic instruments.

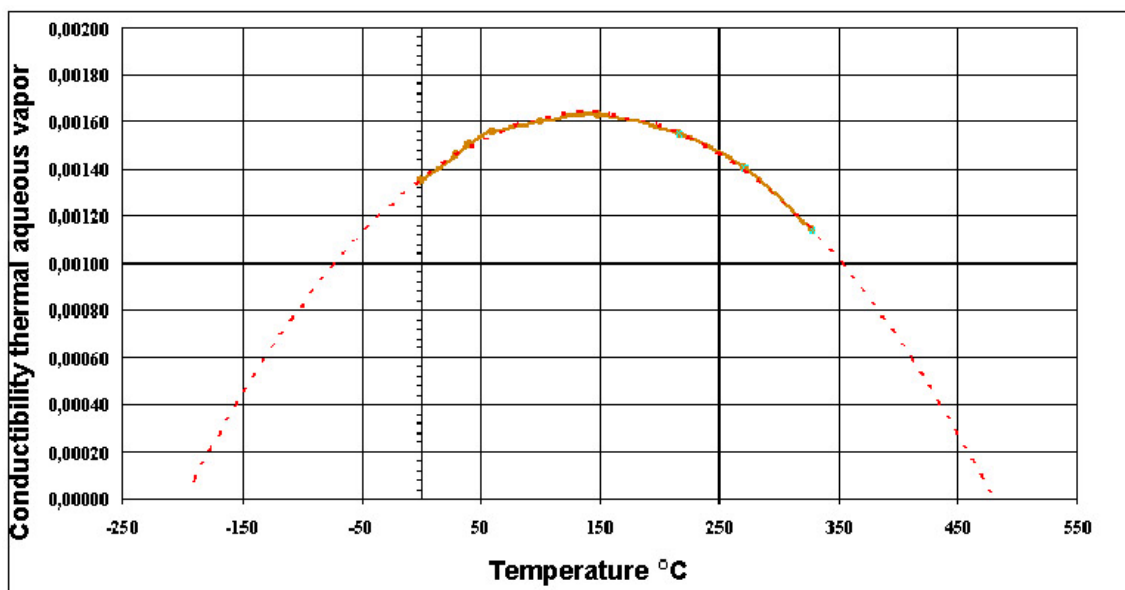
We'll explore later on about their quality and quantity.

**Fig. 5 Describing the Double layer during the ignition phase**

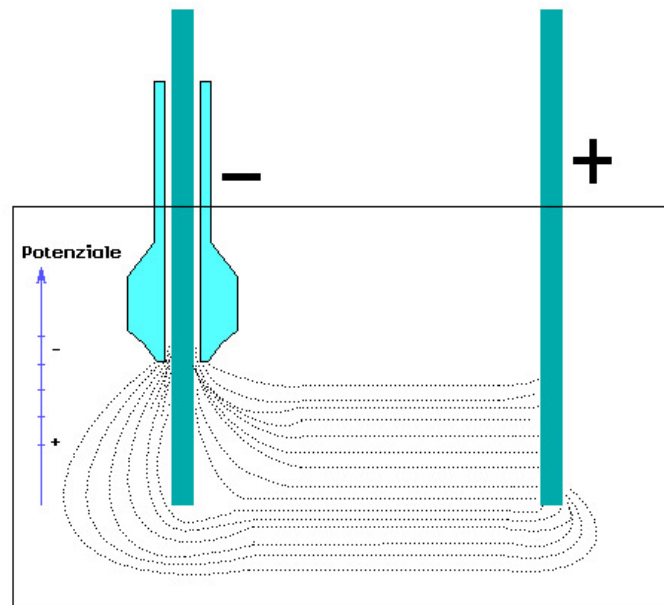


All together, this phenomenon, rises the cathode temperature close to a value of 500°C., giving birth to some important consequences. First of all, the water in the solution, finding itself very close to the cathode, will evaporate instantaneously, generating a sort of vapor-sleeve around it. In this situation, two of the known heat transmission methods, conduction and convection, loose their importance, because the thermal conductivity of the steam, at this temperature, lowers considerably, (fig.6), while irradiation still act fully in this reduced heat transfer efficiency respect to the analogue heat transmission working at temperature close at 100°C. This new regime allows more and more heat around the cathode increasing the double layer temperature.

**Fig. 6 Conductibility thermal of steam**



In such a particular thermal situation the electrical conduction mechanism in the cell shows a new configuration. First of all, the plasma area interested, results to be electrically neutral, seen in a macroscopically way, and does not participate anymore, substantially, to the electrical conduction through the cell. Such conduction is nevertheless guaranteed, in a preponderant way, by the cathode upper part, colder, called **“reaction band”**, which continue to be interested with electrolytics phenomenon formation of gaseous hydrogen. The formation appears reduced because the thermodynamic efficiency of the reaction, at the reached temperature, will assume extremely low values ( $n = 0.9$  at  $100^{\circ}\text{C}$ ;  $n = 0.3$  at  $3400^{\circ}\text{C}$ ). A realistic return of the missing participation to the electrical conduction is given by the reduced conduction current that, after having reached a ripple, in the pre-ignition status, it will stabilize at about  $1 - 1.5$  A during the ignition status (see fig. 3.2), with the current value depending only on the soluto concentration. This, is going to demonstrate that when the cathode surface is interested with the plasma, the electrical conduction is drastically reduced and the electrical lines current are obliged to concentrate into colder areas (see next fig.7).



**Fig. 7** flux of the ions in the solution

To be able to understand this point is fundamental to comprehend the structural characteristic of the cathode ceramic sleeve, called **“reaction chamber”**, which offers, thanks to its geometry, the correct electrical stability to the plasma. The internal diameter of the reaction chamber result to be larger of the cathode diameter to allow a few millimeter differences. Is natural to think that some of the electrolytic solution in going to circulate inside the reaction chamber and wet those parts of the electrode covered with ceramic. This is very important because this part is not interested by the plasma effect. Direct observations did give the right to say that plasma does propagate internally along the sleeve for about 2 mm. In such a way the current lines concentrate inside the reaction chamber where the electrolytic process can continue. As a consequence this cathode area (reaction band) is going to be the unique sector of the electrode able to convey the electrical current that is, also, the maintaining plasma current.

The following X-ray photos picture the tungsten surface. From the very few channels etched by the molecular hydrogen hot gases (photo 1) can be deduced the notably efficiency lowering of production reaction of such gases at elevated temperatures, while from (photo 2) can be clearly noticed the fusion areas of tungsten; supporting the claim that temperature is higher than  $3400^{\circ}\text{C}$ .



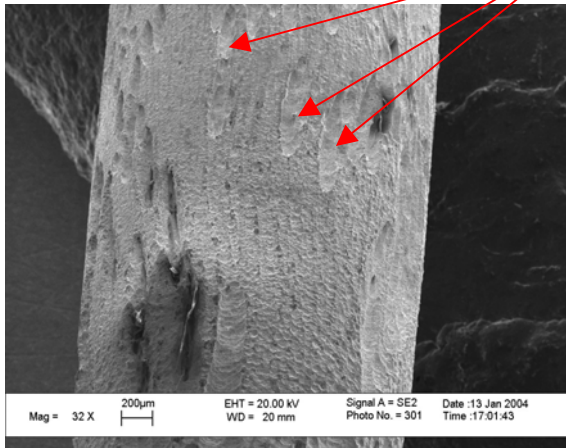
**Worm gas erosion**

Photo 1 Areas etched by the hydrogen gas

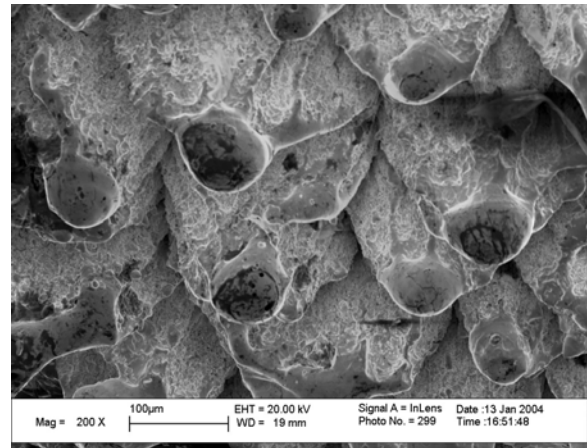


Photo 2 Tungsten fusion is

These findings open the way to an extensive mass of thoughts that requires new analysis, absolutely necessary, to be able to introduce some key-concepts regarding this experimental configuration. One of this is related to the evaluation of the thermo ionic emissions of the cathode tungsten around 3400°C. When the electrode temperature goes over 1000 degree, this new phenomenon shows itself and constitute a fundamental stone in the construction of a satisfying physical model.

As we know, all metals, when warmed over certain values, manifest an electronic emission phenomenon called thermo electronic emission (or thermo ionic effect).

The thermo ionic effect have been studied by researchers Richardson and Dushman and just this phenomenon did give the possibility in 1904 to professor John Ambrose Fleming (1849-1945) to discover the first thermo ionic diode. If we locate, for example, a thin wire of tungsten in the void and we find the way to warm the metal, the way you like, the thermo ionic effect arises when the electrons of this metal are literally shot in the void thanks to the energy coming from the heat.

The normal lamp tungsten filament is also characterized by thermo ionic emissions. The electrons emitted from the metal are attracted straight away by the same and so, if not readily collected by a special electrode, they will return to the emitting filament. In the case of the tungsten electrode submerged into the electrolytic solution of the cell something similar happens. The electrons, energetically activated by the heat and under the thermo ionic effect, starts to oscillate in a coherent way because they are not able to abandon the crystal structure of the metal. In the real case we ought to believe that the oscillations will develop outer the interphase boundary and this is due, also, to the positive potential barrier produced by the potassium ions, able to recall the electrons toward the outside. With the void condition and temperature close to 3400°C., the electronic emission, calculated following the Richardson and Dushman formulas for 2 cm<sup>2</sup> of active cathode portion (average value of the cathode surface utilized during our test), is more than 500 Amperes (see fig. 8). It is a considerable thermo ionic emission. It remains to determine the inter occurring relation between this data and the conditions established into the cell, to be able to evaluate quantitatively the real number of electrons emitted thermoionically at the cathode and that support the plasma and, more than ever, to evaluate the main free path before their capturing.

Another aspect to be determined, via the analytical-experimental way, is the real estimation of the temperature reached around the plasma area, at close proximity of the tungsten cathode surface. We are sure it will be more than 3400°C., otherwise the tungsten won't fuse. We do like to know how much more. If, during further spectral analysis, it could show, inside the plasma phase, some of the characterization lines of the cathode metal, it could be volarized the hypothesis of vaporization,



atomization and ionization of the tungsten into the double layer. If true, the temperatures in the plasma area could reach about 6000°C.

Fig. 8 Tungsten thermoionic emission

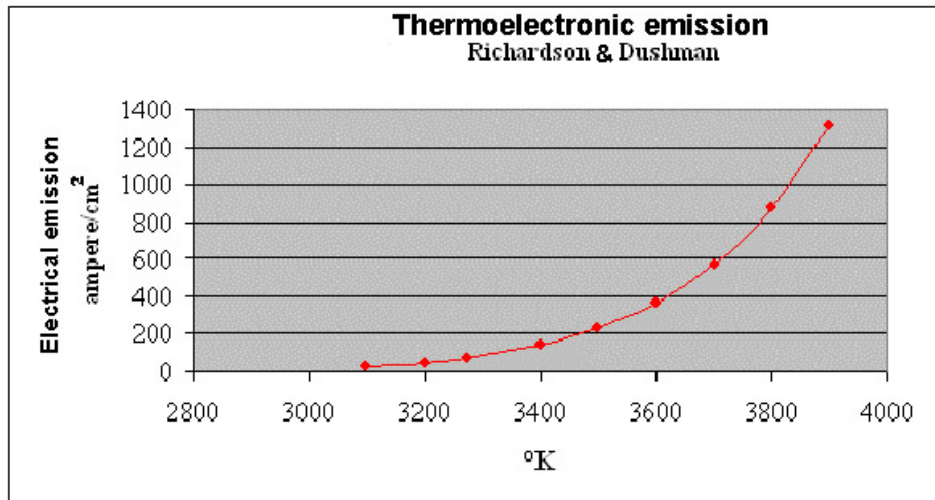
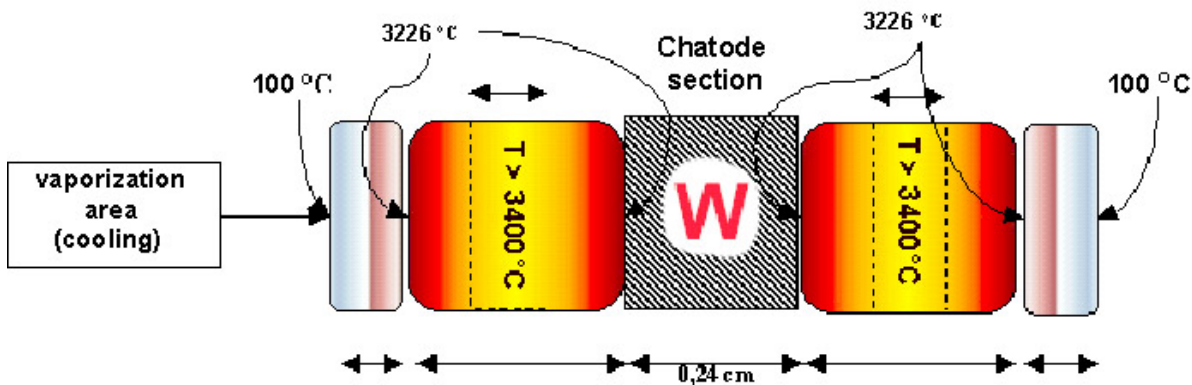


Fig. 9 View of the plasma heat transfer mechanism



An extremely partial analysis, able to provide one esteem of the temperature reached by the cathode, can be made utilizing a model of the heat transfer in which conduction and convection loose all their importance respect to irradiation, considered in such a way the principal thermal dissipaters. Nevertheless, such a model will show strong limits with our reality, because, in its analytical structure won't be appearing thermo radiant phenomenon due to the electrical discharges or electronic striking. Thereafter, the presumed data's, from such analysis, could lead the way to an erroneous interpretation.

To say it better: the heat transfer analysis coming from the Sun, using the irradiating model, let us assume an apparent surface temperature of about 5500°C. But doesn't give us any information on the solar atmospheric temperature, 20.000°C., or more, about that related to its core, 15.000.000 °C. if we refer this calculus to the plasma cell system we need operative hypothesis that will easy the following valuations. First of all, we need to separate the experimental way in two stages. The first is related to plasma ignition and its subsequent heating of all the solution till the reaching of the boiling point, about 100°C. The second stage, defined like stationary phase, comes into consideration from the moment in which all the solution reaches 100°C. till the dying out of the plasma. The irradiating calculus has to be done at this stage, because the transitory of the first stage has a low durability respect to the second one. Another hypothesis that doesn't go very far from

reality is that all the water solution will evaporate only in the second stage. Fixed such hypothesis, calculus than follows. From the experimental data's taken from several tests, estimating an average of evaporated water, it will be obtained a steam flux of 0.14 g/sec. To be able to let evaporate 1 cc. of water (equal to 1 gram) are needed 539.55 cal/g (latent evaporating water heat) we will obtain, on the output a thermal flux equal about to:

$$Q = 539,55 \text{ cal/g} * 0,14 \text{ g/sec} = 76 \text{ cal/sec}$$

Let hypothesize that such thermal flux is coming from the thermal irradiation of the cathode tungsten.

Let regard it like a perfect radiant black body and, not considering the losses, we'll have, using the Stefan-Boltzman relation, that the thermal flux is equal to

$$Q = A \sigma (T_p^4 - T_s^4)$$

Where "Q" is indicated the thermal flux in cal/sec, with "A" is indicated the radiant surface of the exposed cathode portion resulting 2 cm<sup>2</sup>, say 2 10<sup>-4</sup> m<sup>2</sup>, with "σ" we indicated the Stefan-Boltzman, equal to 4,88 10<sup>-8</sup> kcal/h m<sup>2</sup> K<sup>4</sup>, with "Tp" is indicated, in Kelvin, the cathode temperature, equal to 373K (100°C.). Adapting the measuring units and equalizing the two thermal fluxes it can be obtained a temperature on the cathode of about 2300 °K (2030°C.) that means about 1400°C. smaller of the tungsten fusion temperature; strengthening what has been said previously. This thermodynamic model results to be profoundly inadequate to analyze the plasma irradiation; the cathode more than 3400°C. over-temperature is not justified (see photo 2). Lets say more that, still considering the tungsten a thermo radiant body not completely black and with an admittance "ε" of 0.2 (the smallest value for admittance related to tungsten found in the literature) to be inserted into the formula  $Q = \varepsilon A \sigma (T_p^4 - T_s^4)$  we will obtain a plasma temperature of about 3170°C., still lower than the 3400°C. referred to fusion.

#### 4. Experimental evidences.

Once the ignition test is concluded and the enduring stable plasma on the cathode cell has been achieved for more than 500 sec., we can compare the input energy, electrical power, with *only* the quantity of energy necessary to warm-up and evaporate the solution water, *omitting* to consider chemical type phenomenology, that requires energy too, *omitting* to consider the energy related to the heating-up and fusion of the tungsten, *omitting* to consider the expansion work given by the exit of gas and steam from the cell, *omitting* to consider the energy emitted by the external thermal irradiation from the cell, *omitting* to consider the electromagnetic energy associated to the plasma emissions, *omitting* to consider the losses regarding the missing insulation of the system, *over-unity rendering can be always achieved*. Practically, making into account the energy needed by the water to warm-up till 100°C. and evaporate, with the energy electrically inputted to the cell to get it working, values of 1.2 till 1.4 can be obtained. All that means to say that the energy at the exit, referred only to the quantity absorbed from the water, is 120-140% of the input energy.

Another data of extreme importance, always following the final test analysis, brought us to find, onto the cathode surface, with the support of a S.E.M. (Electronic raster microscope) the presence of renio, osmio, gold, afnio, tulio, erbio and itterbio, previously absent from the experimental apparatus. Later on we'll analyze in great details such results.

#### 5. Thermodynamic problems and output energy measurement

The heat quantity originating from the cell is due, mainly, to the current circulation into the solution (joule effect) and to the radiant energy produced by the ignited plasma at the cathode. The measure

of part of this heat quantity is done, as we said previously, referred only to the water warming and evaporation. We do it through the drawing of the input and final temperatures, united to the precise measure of the water quantity lost during evaporation. The formula which keeps accounts for it is:

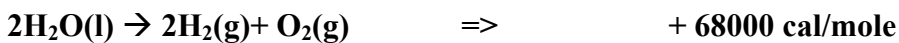
$$Q_{uscita} = m_{H_2O} \cdot (T_2 - T_1) \cdot cp_{H_2O} + m_v \cdot 539,55$$

With “ $m_{H_2O}$ ” is the solution initial quantity (200cc.), “ $cp_{H_2O}$ ” is the water specific heat at constant pressure, “ $m_v$ ” is the vaporized quantity of water, “539,55”) is the water evaporation heat given in cal/g, and “(T2-T1)”, finally, is the initial and final temperature difference of the test.

This method gives a precision of +/- 250 cal. It is important to point out that the specific heat at constant pressure of the solution have been approximated to one, despite is not pure water but a solution containing K<sub>2</sub>CO<sub>3</sub> at 0.2 M. Nevertheless, calculating exactly the specific heat of the utilized solution and keeping into account its exact density, the true error we have, results to be a lot less than the precision limits compelled by the instrumentations related to the output calories measure.

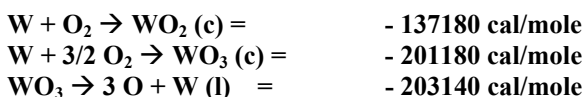
As previously said before, the analysis of the output energy, always keeping in mind instrumental problems reliability, is referred to water heating and evaporating energy only. Nevertheless, the energetic phenomenon not explored in this phase are various.

Henceforth the water molecule scission requires its part of energy:



It should be useful to quantify the moles of gas produced to comprehend fully the energy percentage required by the reaction. On the same way the anodic electrode and the cathode electrode are affected by a certain weight reduction, still by different causes, but requiring exchanging energy with the environment. At the cathode the consumption of the material depends from the fusion process generated from the plasma temperature and by dynamical processes related to the hot gases action.

At the anode, instead, we have tungsten dissolution of two kinds:



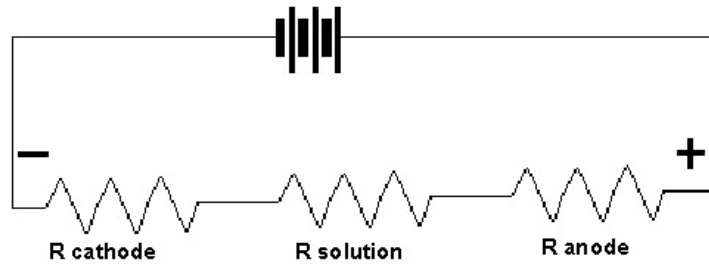
These reactions dissipate part of the anodic material and enrich the solution with tungsten oxides. To be precise, these reactions, being esoenergetic, contribute to the solution heating. Luckily the energy range in play is comparable with that required by the cathode phenomenology. Their global contribute is very low.

Another important characteristic of the plasma cell, is the intrinsic propriety to produce strong electromagnetic disturbances. Signals, which are spacing into a vast range of radio waves, say between kHz and hundred of MHz, are gathered as disturbance by the interfacing thermocouple systems. These signals are originated, without any doubt, from the plasma and are the proofs that oblige us to look at it as a real plasma, despite its confinement in a liquid surrounding.

To this proposal, a systematic study of the plasma, from this point of view, requires the examination of the circuit behavior of the cell in its globality.

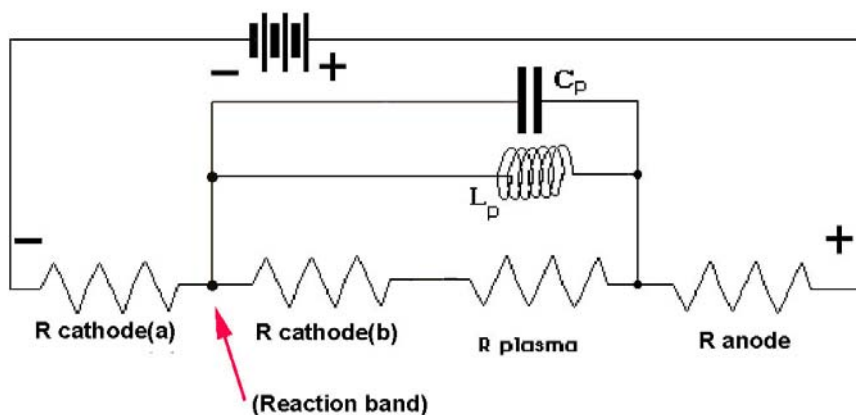
The equivalent circuits of the cell, having in mind the new phenomenon, can be outlined as shown in the following figures.

Equivalent diagram



This circuital scheme is valid only when the process is far from the plasma condition and it is in the normal electrolytic regime. The electrodes resistances, are shown, but they can be easily ignored in this case.

When, on the cathode, it is displayed the ignition plasma phenomenon, the circuit changes and so has to be reviewed. The solution resistance can be ignored because very small, but in its place we need to introduce the new concept of 'plasma ohmic resistance', which gives the possibility to justify, in some way, the obstruction that the plasma create to the electric current circulation. Nevertheless, to analyze the phenomenon only from the ohmic point of view is not enough; the plasma is emitting abundant electromagnetic waves too. With this purpose, further to the resistance and the virtual condenser, the plasma is accompanied by a proper inductance value. The next scheme is showing us a precise configuration which corresponds to the plasma condition at regime.



On it, with  $C_p$  we indicate the tungsten-potassium virtual condenser; instead with  $L_p$  we indicate the plasma inductance. With this equivalent circuit we can explicit a route about the formation of temporary oscillation circuits, beginners of the electromagnetic disturbance emissions. From a physical point of view the inductance presence can be explained by means of the oscillations of coherent group charges that, moving inside the plasma, simulate a certain inertia in the electric conduction, typical of inductors. The equivalent circuit shows too a cathode resistance made of two terms ( $R_a$  and  $R_b$ ). In effect, this layout should justify what we said previously about the electrical conduction at the cathode, say, cause the strong heat, this sector of the electrode, under the plasma presence, has an ohmic resistance certainly bigger of the sector enclosed inside the ceramic cathode cover. The highlighted point by the arrow shows the area called 'reaction band' where is circulating, following what have been verified, the cell maintaining current. The complete analysis of the electromagnetic sector spectrum emitted from the plasma should give us an esteem of the diffused energy by terms  $R_a$  and  $R_b$ . At the moment this data's is still to be determined.

Does not result, likewise, calculated the quantity of energy consumed by the cell as expansion work of the gases (H<sub>2</sub>, O<sub>2</sub>, overheated steam) which develops at the electrode, since, always linked with the instrument problems, have not been possible to evaluate the volume of the gas produced, as a consequence we have not been able to give a value to the 'ΔV' which appears in the equation:

$$E_{(\text{expansion})} = P \cdot \Delta V$$

Which gives the energetic value of an isobar expansion.

Does not result calculate the energy quantity under the form of luminous flux outpouring from it.

The thermal losses of the system, instead, if it is analyzed like a calorimeter, are determined and are arranged, approximately to 25% of the value of the input energy (Q<sub>ingresso</sub>). Practically, without igniting the plasma, giving electrically 100 cal. to the cell, 75 cal. will be transformed in useful heat to warm-up the solution, 25 cal. will be dispersed into the environment cause the bed insulation of the cell respect to it.

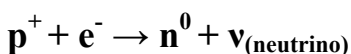
## 6. Energetic estimation.

To be able to determine the cell efficiency, at the end of each test, we measure the total energy electrically delivered to it from the supply system. This measure is executed, as we said previously, utilizing a VIP SYSTEM 3 meter from Elcontrol, ad more, contemporaneously, an ulterior measure through the integration of the voltage and current slopes detected by the computer interfaced with the cell. The VIP meter is connected at the net input just after the variac exit. The choice of this type of circuit includes, into the computation of the input energy, the electric losses, too, of the power supply, locating the system largely distant from possible overestimated errors of the output energy. The energy measured by the instrument is, for convenience, expressed in calories.

The ratio between the output water energy, measured only on the water and the output one, gives, as have been said previously, efficiency values from 1.2 to 1.4. Considering the fact that the output energy contribution, from a real point of view, is certainly more, cause of what we said, and left apart, we ought to consider that internally to the cell are existing secondary flux production of energy of unconventional nature.

Assuming that, in a system of this kind, the energy derives from nuclear phenomenon, we tried to build-up, with caution, a theoretic construction to justify the surplus of energy, and above all the presence of news chemical compound found on the cathode.

In this model, the plasma presence is playing a first place role. From its starting and till the reaching of stable working condition we have electrons and protons underpinned to continuous repetitive reciprocal clashes with such elevated frequency to be able to catalyze the following reaction, called "electronic capture"



In this reaction the proton, instead of capturing the electron to generate one hydrogen atom, it joins to it to form one neutron. Until this reaction can happens it needs, nevertheless, to operate an esteem of the necessary energies starting from a valuation able to indicate from how much the neutron rest mass results greater than the proton and electron masses.

First of all, the difference from the neutron mass, of value  $1,6749543 \cdot 10^{-24} \text{ g}$ . And the sum of the electron mass ( $9,109534 \cdot 10^{-28} \text{ g}$ ) and proton ( $1,6726485 \cdot 10^{-24} \text{ g}$ ) is equal to  $\Delta m = 1,395 \cdot 10^{-27} \text{ g}$ .

As a consequence it is necessary to supply from the outside enough energy able to cover such mass deficit. To reach the goal we look to the Einstein  $E = m c^2$  were, as a mass, we utilize the difference between the neutron mass and the sum of the electron and proton masses. Substituting the numerical value and transforming the result in calories, we think to be able to obtain a neutron with the previous reported reaction, it is needed an energetic quantity equal to about  $3 \cdot 10^{-14}$  Cal., equivalent to about **0,784 MeV**, calculated without considering the gamma emission and the neutrino mass which are absorbing part of this energy.

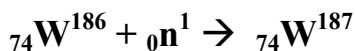
Is immediately evident that, to happens, this reaction must absorb energy from the cell system, and as a consequence, should behave in an exactly speculative manner respect to what experimentally found. Practically, it should not emit an energy surplus, but should adsorb some from the system cell cooling it down. However, excluding the 'what' and 'how' this reaction is going to start, it constitute only a very first dowel of all the mechanism, with the deriving consequences opening the way to justify the phenomenon, esoenergetic and transmutation, we found experimentally.

Obviously, considering the energy 'cost' of this reaction, not all the electrons and protons can be transformed into neutrons, rather is thinkable that only a small part of the present quantity in the plasma will behave in the reported manner by the reaction we have been talking about.

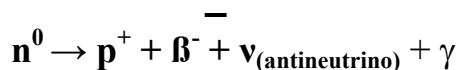
Such a reaction, lighted by this newly acquired energy consideration, can be written in the following new way:



Even tough a small part of neutrons could be generated from such a mechanism; it is possible think that, provided with adequate collision strength, can be absorbed by the tungsten nucleus following the relation:



When such nucleus will become unstable because of an excess of neutrons, one of them will decay transforming itself in one proton, which remains into the nucleus and one electron beta which will be emitted following the relation:



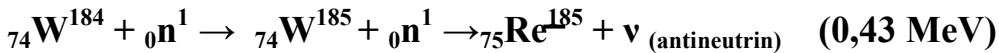
Such a relation, called 'negative beta decay' induce an **isobaric transition**, this will means that the **Z** number, characterizing the number of protons currently in the nucleus, increases by a unity and the tungsten atom transforms itself in a different chemical element, located to the right of the Mendelejev table: the renio. Likewise, the number **A** remains as it was. At the moment for the physics the freed energy from the neutron transformation into the proton will become kinetic energy of the electron (beta) and of the antineutrino (particle without mass), which are expulsed from the nucleus inducing excitation and the consequent loss of excitation, with the emission of a gamma photon. The energies of the particle beta and of the antineutrino are not foreseeable and distribute in a continuous spectrum values following a probabilistic module, instead that of the gamma photon is characterized for every radionuclide and can assume only discrete level of energy. Obviously, if about 0,784 MeV are needed to produce one neutron, the same amounts are going to be produced in the inverse reaction, following the relation:





However, this ‘ inverse’ reaction carries with it an energy advantage that helps further the plasma state to generate ulterior electronic captures; in fact, one generate the beta particle from this kind of decay. **It is equipped inside itself with enough kinetic energy to give birth, trough the joining with a proton of the plasma, to the formation of another neutron that, once again, if carries the right collision strength, penetrate into the tungsten nucleus, repeating once again the mechanism already explained previously.**

The next reaction is an example of how it could be going the isobaric transition or the tungsten atom transmutation which had the opportunity to absorb one neutron



following always the same mechanism, which from the neutron absorption leads to the nucleus instability and to the consequence transmutation, the following nuclear reactions, already known to nuclear physics, are possible



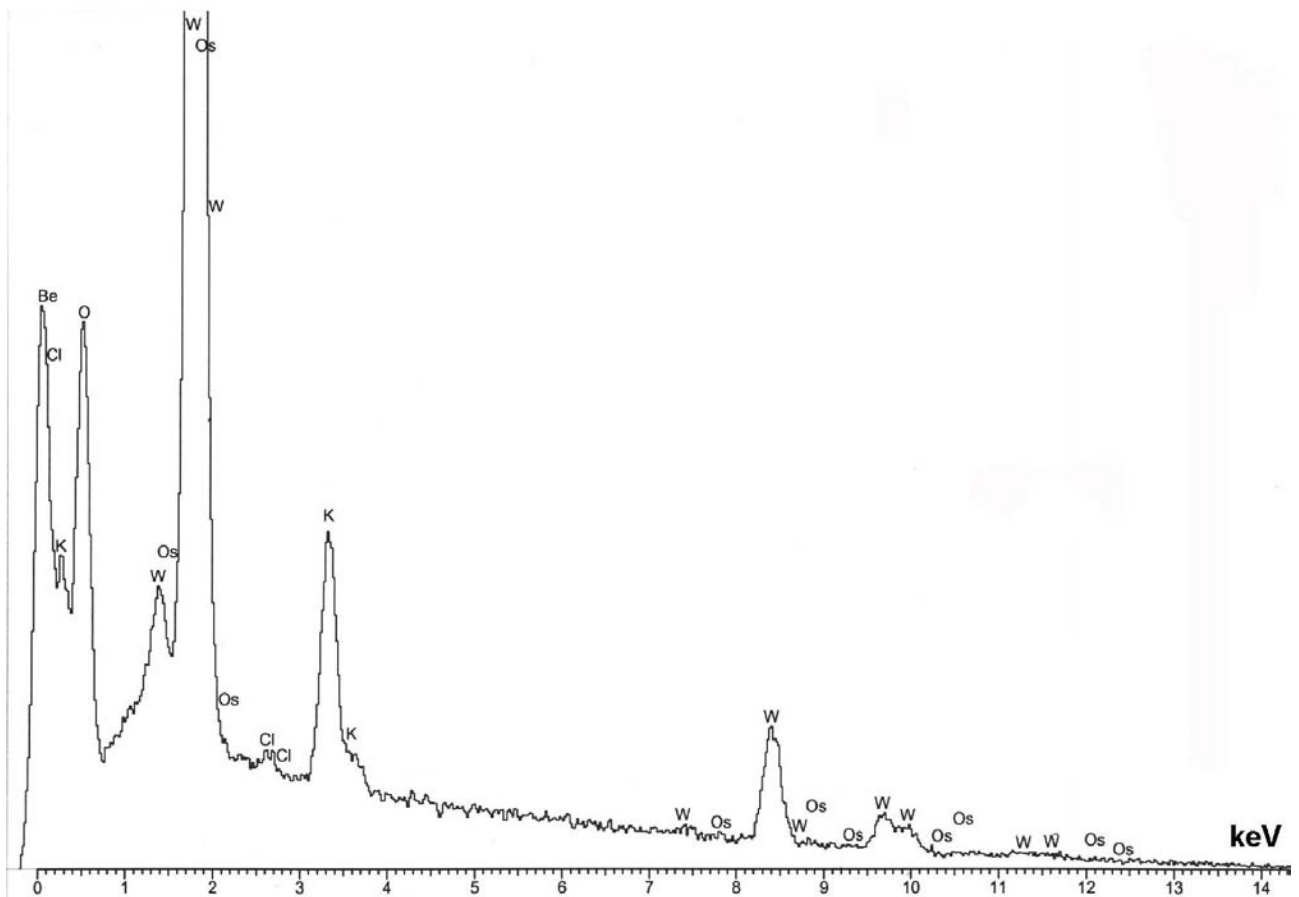
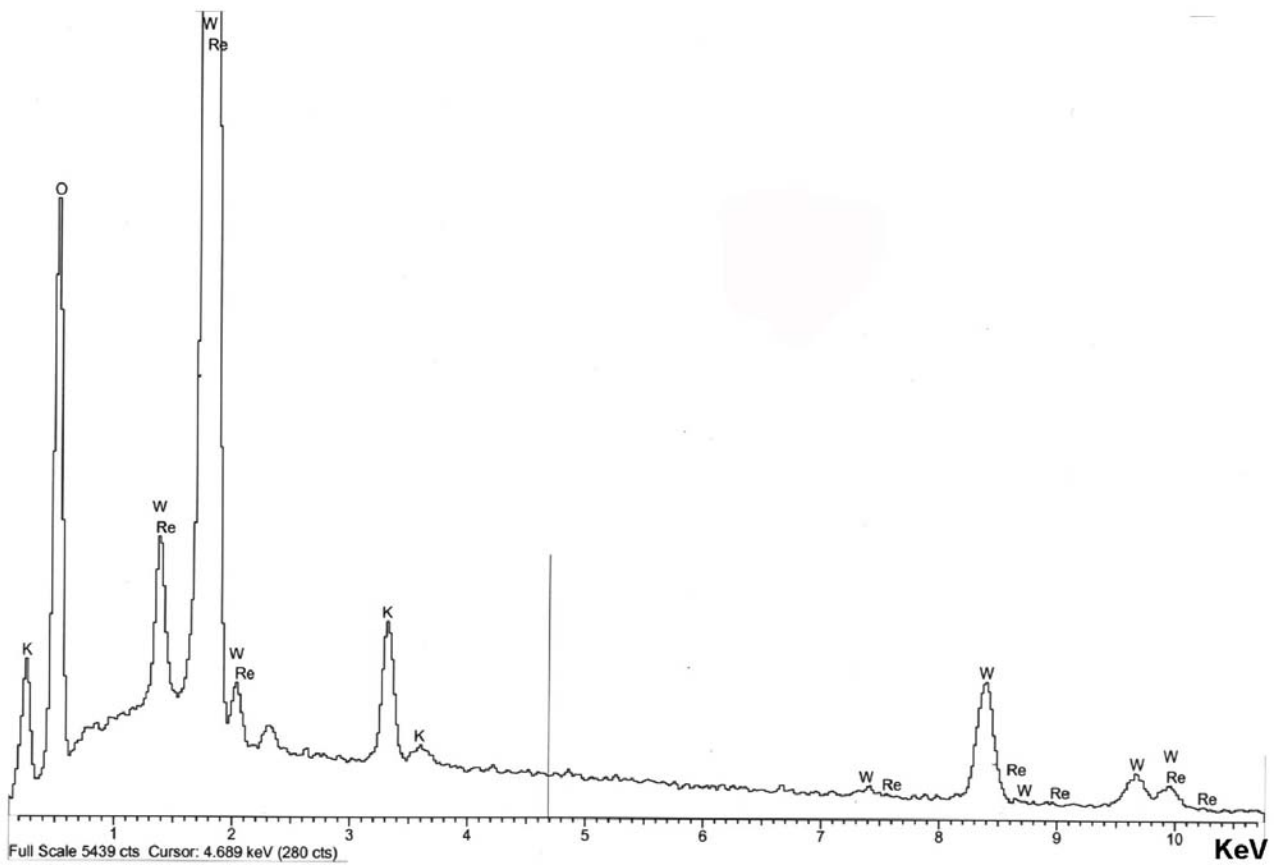
all the nuclides depicted in these reaction have been reveled onto the cathode surface.

In the table n.1 are reported some tungsten isotopes decays; we noted that for some of them the decay comes by beta particles emission, while the products obtainable are constitute of renio and osmio, founded like imprint on the tungsten electrodes surface, as seen in photo n.1 and photo n.2 of page n.8 which represent some of the X-ray analysis executed onto tungsten electrodes after many plasma cycles.

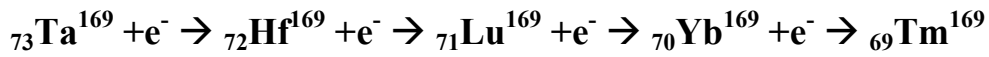
Table 1: The Radioactive Nuclides of Tungsten

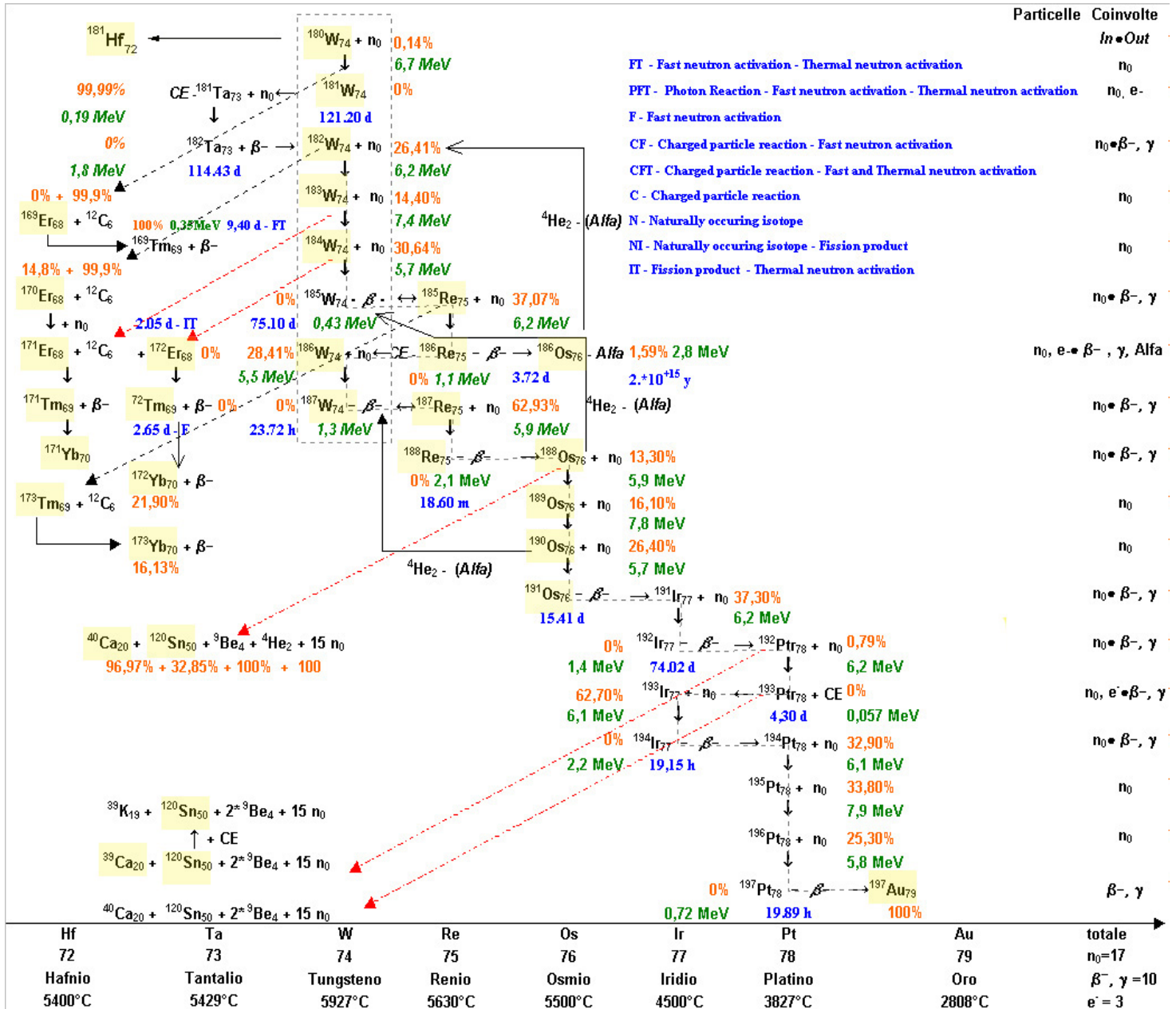
Radio-nuclide	Half-life	Mode of Decay	Energy of Radiations, Mev	Produced by
$W^{176}$	80 m	EC (99%) $\beta^+$ (~0.5%)	$\beta^+$ : ~2.0 $\gamma$ : ~1.3	W-dp-4n
$W^{177}$	130 m	EC	$\gamma$ : ~0.5; 1.2	W-dp-4n
$W^{178}$	21.5 d	EC	$\gamma$ : ~0.3 (weak)	W- $\gamma$ -2n, W-n-3n, W-dp-3n
$W^{179}$	30 m	EC	$\gamma$ : 0.030	W- $\gamma$ -n, W-n-2n, W-d-t, W-dp-2n
$W^{179}$	5.2 m	EC or IT	$\gamma$ : 0.22	W- $\alpha$ -cn, W-p-pn
$W^{181}$	145 d	EC	$\gamma$ : 0.136; 0.152	$W^{180}(n,\gamma)W^{181}$
$W^{183m}$	5.5 s	IT	$\gamma$ : 0.105; 0.155	$W^{182}(n,\gamma)W^{183m}$
$W^{185m}$	1.62 m	IT	$\gamma$ : 0.130; 0.165	$W^{184}(n,\gamma)W^{185m}$ $Re^{185}(n,p)W^{185m}$ a $Os^{188}(n,\alpha)W^{185m}$ a
$W^{185}$	73.8 d	$\beta^-$	$\beta^-$ : 0.430 $\gamma$ : None	$W^{184}(n,\gamma)W^{185}$ $Re^{185}(n,p)W^{185}$ a $Os^{188}(n,\alpha)W^{185}$ a
$W^{187}$	24.0 h	$\beta^-$	$\beta^-$ : 1.33; 0.63; 0.34 $\gamma$ : 0.0721; 0.1062; 0.1138; 0.1343	$W^{186}(n,\gamma)W^{187}$ $Os^{190}(n,\alpha)W^{187}$ a $Re^{187}(n,p)W^{187}$ a
$W^{188}$	69.5 d	$\beta^-$ (?)	$\beta^-$ : ? $\gamma$ : ?	$W^{187}(n,\gamma)W^{188}$ b

Fig. 10. analysis executed with a raster microscope upon an area of the cathode surface



Despite this, the nuclides presence that are preceding the tungsten as atomic number and that have been detected on the cathode electrode (afnium, tulium, erbium, ytterbium), are fully explained through electronic capturing reactions similar to the ones seen previously that however, in this particular case, permits to obtain protons and electro transformation into neutrons, directly inside the nucleus interior, by the electrons acquisition coming from the plasma. Just under are shown a series of reactions of electron capturing, known to the nuclear physics, in which, starting from the tantalum (element that precedes by one position the tungsten) we'll arrive at the hafnium and at the tulip passing through the ytterbium, squaring-up perfectly what as been found onto the electrode:





The preceding image shows the main types of radioactive decays envisaged and afterward founded by the measures made during the experiment. The outlined rectangle, in which the tungsten isotopes are shown, is considered the origin of all series of its nuclear reaction.

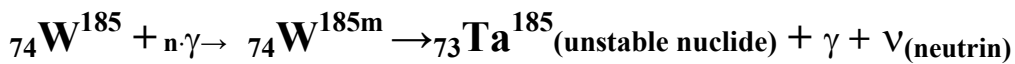
The elements inside the yellow square have been caught with the help of the S.E.M. (electronic raster microscope).

The manners, in which, operatively, it is possible to obtain electronic capturing reactions, going over the energy limits that, in the first analysis, seem forbidden, are to be searched in the possibility given with the presence of a stable state of plasma. It, thanks to the continuous clashing amongst the present ions and thanks to the energy vivacity due to the photons generation, could favor the birth of a tunnel type effect that lowers the local energy barrier, opening the possibility to determinate the reactions of electronic capturing to happen more easily. A reasonable aid to exceed such energy barriers could be found by the upsurge of photonuclear reactions which, for example, could favor this process giving energy to the proton and taking it in a metastable excited state, reducing in this way the requested quantity of energy to the neutron formation. A reasonable mechanism by which could happens these particular photonuclear reactions could be the following: inside the plasma the

electrons, which moves under the presence of a strong electric field, assume a really high kinetic energy, cause, as known, it results proportional to the electrical field applied externally. In such conditions, if two electrons clash together, they will generate a photon to which will be transferred part of the kinetic energy of the incident electrons; this photon, once again, can be easily absorbed by the proton which reaches, in this way, in an excited or metastable state. If the proton absorbs a high number of photons happens that the necessary energy needed for the electronic capturing will be reduced considerably and as a consequence the probability of its happening will be notably increased. A possible reaction in which the excitation action enhanced by the photons could be the following:



From this hypothesis descent naturally the following reaction which describes the transmutation process of tungsten into tantalum, enhanced by photo excitation:



In this case, too, the absorption of a certain number of gamma photons from the tungsten atom, will generate a metastable form that itself decays into tantalum with an emission of one gamma photon and the production of energy.

A second hypothesis, that could justify, the lowering of the energy existent barriers, could be founded on the presence of a tunnel type effect that could increase substantially the probability that the emitted tungsten electrons clash in a useful way with the proton and can determinate, with a lesser 'energy expense', the proton formation.

The certainty that, in the neutrons generation, prevails one of this mechanism, is still far away from being reached, cause, despite the astonishing results collected related to obtain energy productions and nuclear transmutation reactions, this series of interesting evidences still needs a profound campaign of analytical-experimental researches.

Anyway, not considering the mechanisms acting on a microscopic level, the surveying conducted on the macroscopic level focus the attention especially onto the important role assumed from the active tungsten cathode surface. For active surface it is not mean the geometric surface but the real electrode surface with its scratching and micro porosity. We noticed that a strong increase in this active area rises the nuclides quantity produced allowing the instrumental detection.

The dimensional extension of this active surface is linked to the type of treatment the electrode is subjected. New electrodes, being strongly compact, cause not yet subjected to any kind of treatment, does not show a very large active surface; however, if interested with a plasma phase, in which the temperatures are not enough to let some of the material fuse or evaporate, the active surface is seen to grow in time, vice versa high temperature let evaporate the material saturating the plasma and compacting the surface of the tungsten. With these findings, it results evident that a major nuclides quantity can be obtained when the surface reaches its maximum porosity. The birth of this surface condition is influenced by many big factors, say, first of all, the total mass of the cathode tungsten\*, the temperature, the voltage value, the plasma timing, the kind of working transformation endured by the electrode ( synthesized, extruded), etc. It is evident the existence of limited conditions in which the said factors must be configured to be able to produce a great quantity of nuclides.

The real problem is that, not being all this parameters rightly determinable, it remains, anyway, a uncertainty degree of reproducibility of the experiment. So, it could happens that, with similar operability conditions, we are going to obtain substantial different values.

Note\*: the greater the tungsten mass the quicker the heat can be eliminated from the surface, despite the very high temperatures reached, in this way a bigger porosity is obtainable. Vice versa small



masses does not eliminate very well the heat and the temperature raises quickly reaching fusion values in which the porosity, in the last analysis, is diminishing.

One of the parameter escaping the control, let's say, is the extension true value of such active area, cause, being the last one characterized by a certain etching, it results difficult to evaluate in a precise manner with the actual, on the field, instrumentation. More, the same active area, after optimally working to produce energy and nuclides, can, in a new test, give results completely different, because has been undergoing a plasma phase, the high temperatures and partial fusions can completely change its morphology, at the beginning so efficient.

**Final conclusions**

What we can conclusively say with this treatise is that, once obtained, the plasma, with certain characteristic and stable inside the aqueous solution, is able to catalyze electrons capturing reactions which gives generation to neutrons, which reacting in the way we said, are inducing spontaneous radioactive decay. Such decays, strongly esonergetic, further, are giving birth to new chemical species and are the main causes of the surplus energy production instrumentally perceived. It remains to establish, from an experimental physical point of view, the exact parameters configurations which are able to risen a precise nuclides production. We are exploring the possibility to potential the system energy efficiency.

Fig 11. Chemical reactions and nuclear process that happen on the cathode double layer

